

A	B	C		D
1	AV1-116	375	524	1/2
2	AV1-117	375	524	1/2
3	AV1-118	375	524	1/2
4	AV1-307	620	524	1/2
5	AV1-206	1290	524	1/2
6	AV1-207	1290	524	1/2
7	AV1-509	500	140	1/2
8	AV1-507	500	140	1/2
9	AV1-510	563	140	1/2
10	AV1-911	500	580	1/2
11	AV1-910	402	642	1/2
12	AV1-013	200	1270	2/2

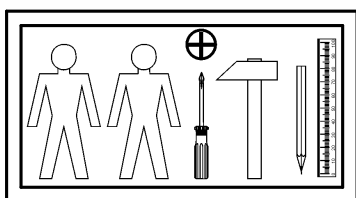
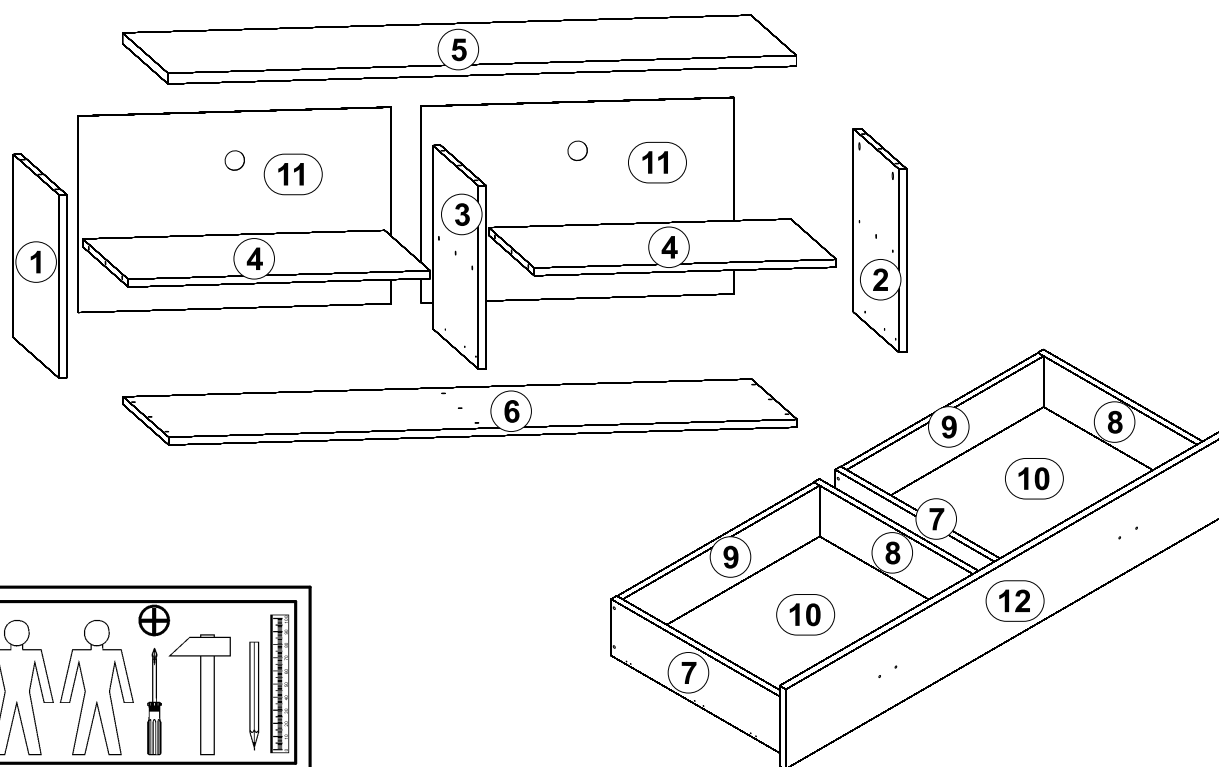
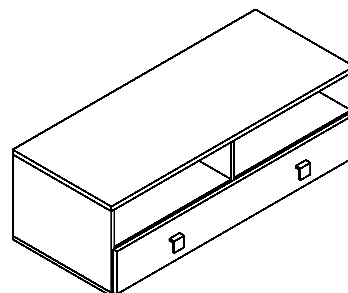

УВАГА!

ФАСАДИ, ОБКЛЕЄНІ ГЛЯНЦЕВИМИ ПЛІВКАМИ, МАЮТЬ ЗАХИСТНУ ПЛІВКУ, ЯКУ ПОТРІБНО ЗНЯТИ ПІСЛЯ МОНТАЖУ ФАСАДУ. ПОВЕРХНЮ ЦИХ ФАСАДІВ МОЖНА ЧИСТИТИ НЕ РАНІШЕ, НІЖ ЧЕРЕЗ 4 ТИЖНІ ВІД МОМЕНТУ ЗНЯТТЯ ЗАХИСТНОЇ ПЛІВКИ.

ВНИМАНИЕ!

ФАСАДЫ, ОКЛЕЕННЫЕ ГЛЯНЦЕВЫМИ ПЛЕНКАМИ, ИМЕЮТ ПРЕДОХРАНИТЕЛЬНУЮ ПЛЕНКУ, КОТОРУЮ СЛЕДУЕТ УДАЛИТЬ ПОСЛЕ МОНТАЖА ФАСАДА. ПОВЕРХНОСТЬ ЭТИХ ФАСАДОВ МОЖНО ЧИСТИТЬ НЕ РАНЬШЕ, ЧЕМ СПУСТЯ 4-е НЕДЕЛИ ОТ МОМЕНТА УСТРАНЕНИЯ ПРЕДОХРАНИТЕЛЬНОЙ ПЛЕНКИ.

НАЗАР АУДАРЫҢЫЗ!

ЖЫЛТЫР ҚАҒАЗБЕН ЖЕЛІМДЕЛГЕН ФАСАДТАРДЫҢ МОНТАЖ ЖҰМЫСТАРЫНАН КЕЙІН АЛЫП ТАСТАЛЫНАТЫН ҚОРҒАНЫС ҚАБАТЫ БАР. ОСЫ ФАСАДТАРДЫҢ ЖОҒАРҒЫ БЕТІН ҚОРҒАНЫС ҚАБАТЫН АЛЫП ТАСТАҒАННАН КЕЙІН 4 АПТАҒА ДЕЙІН ТАЗАЛАУҒА БОЛМАЙДЫ.

2x c400	6x Ø7x50 mm e1	9x Ø6x13 mm e3	8x Ø5x50 mm e32	8x Ø8x30 mm f1	1x Ø8x50 mm f6	6x k27	45x l1	
3x Ø3,5x13mm p1	4x Ø4x30 mm p9	12x Ø5x12 mm p54	22x Ø15x12 mm #16 r1	2x r10	18x r16	14x Ø16 s2	1x z1	
2x 500 mm w26^{DR}	2x 500 mm w26^{CR}	2x 500 mm w26^{DL}	2x 500 mm w26^{CL}					

1

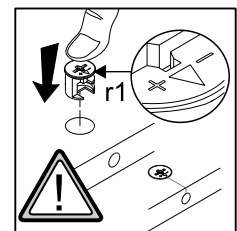
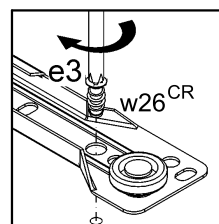
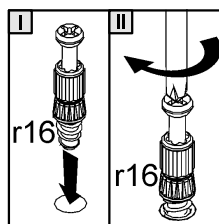
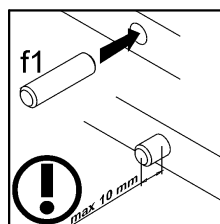
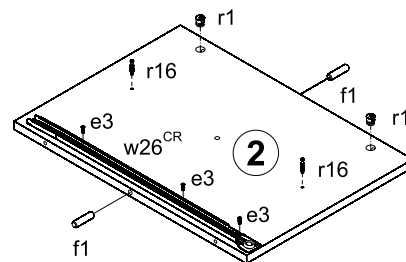
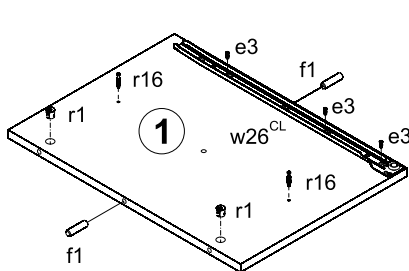
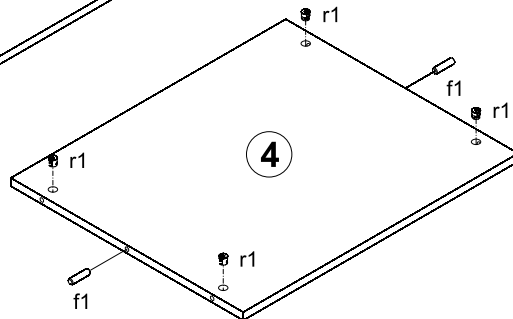
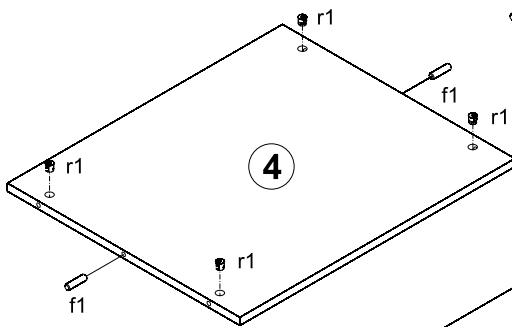
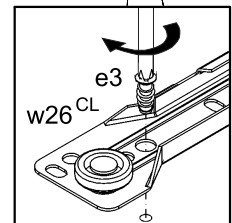
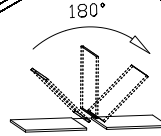
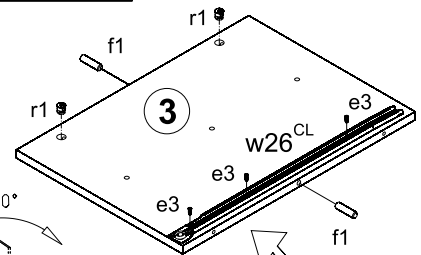
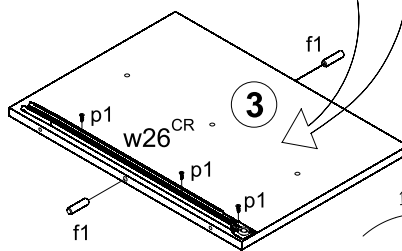
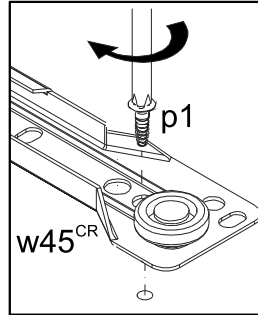
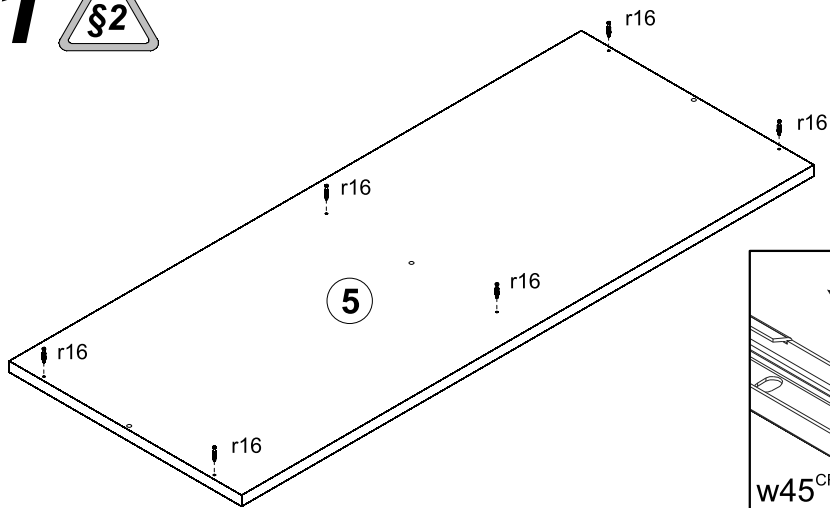

2

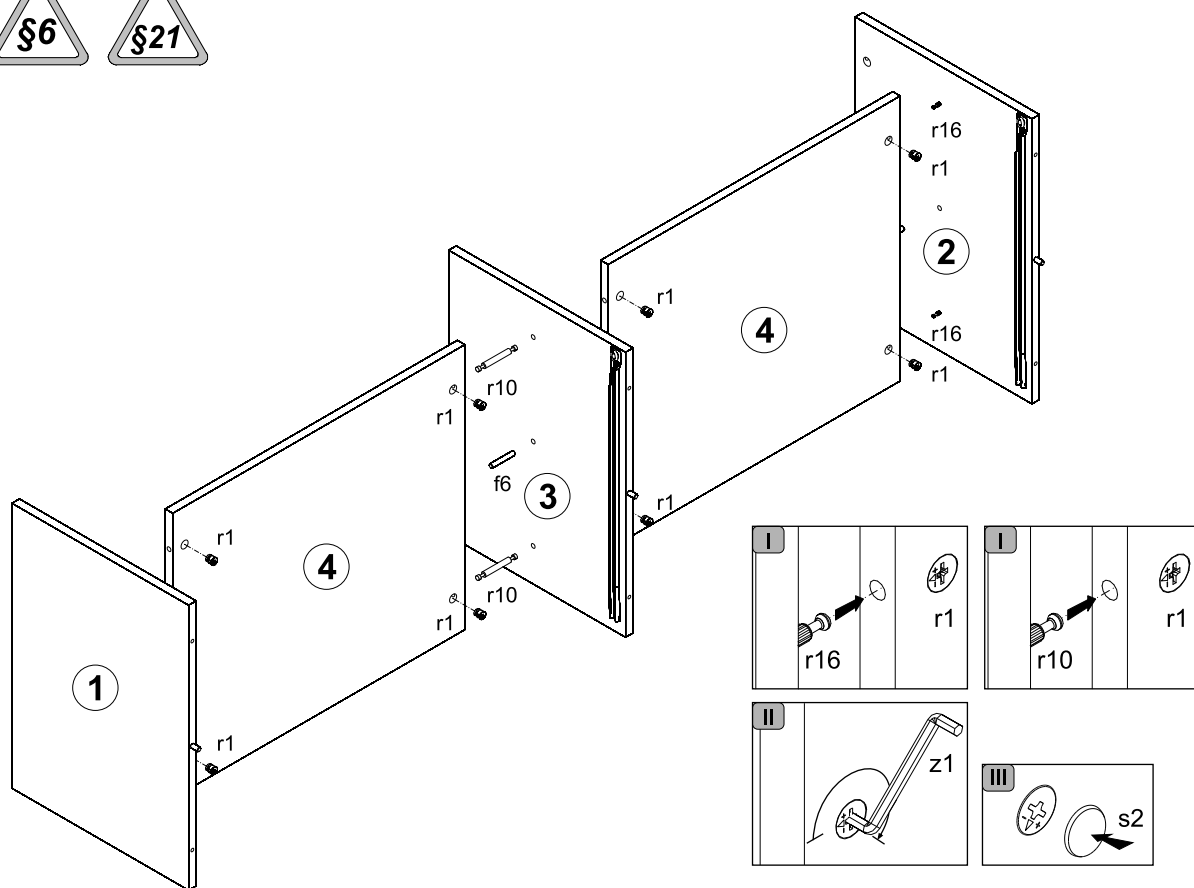

3

